

# Jagram-Pro S.A.

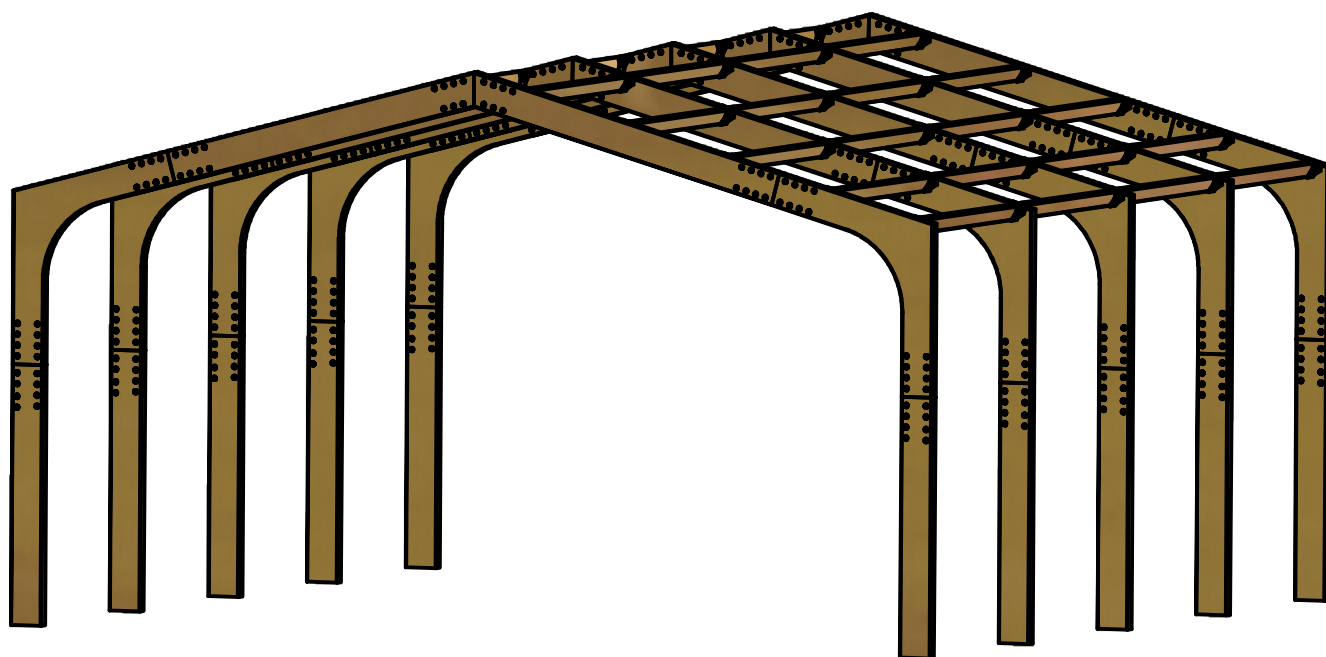

## KONSTRUKCJA MODUŁOWA 60x200

L = 580 cm

W = 560 cm

R500 - 105°

**Jagram-Pro S.A.**

ul. Leśna 16 14-240 Susz POLAND

tel. +48 55 2788497 fax +48 55 2786051

handel@jagram.pl

<http://www.woodandarch.com/>

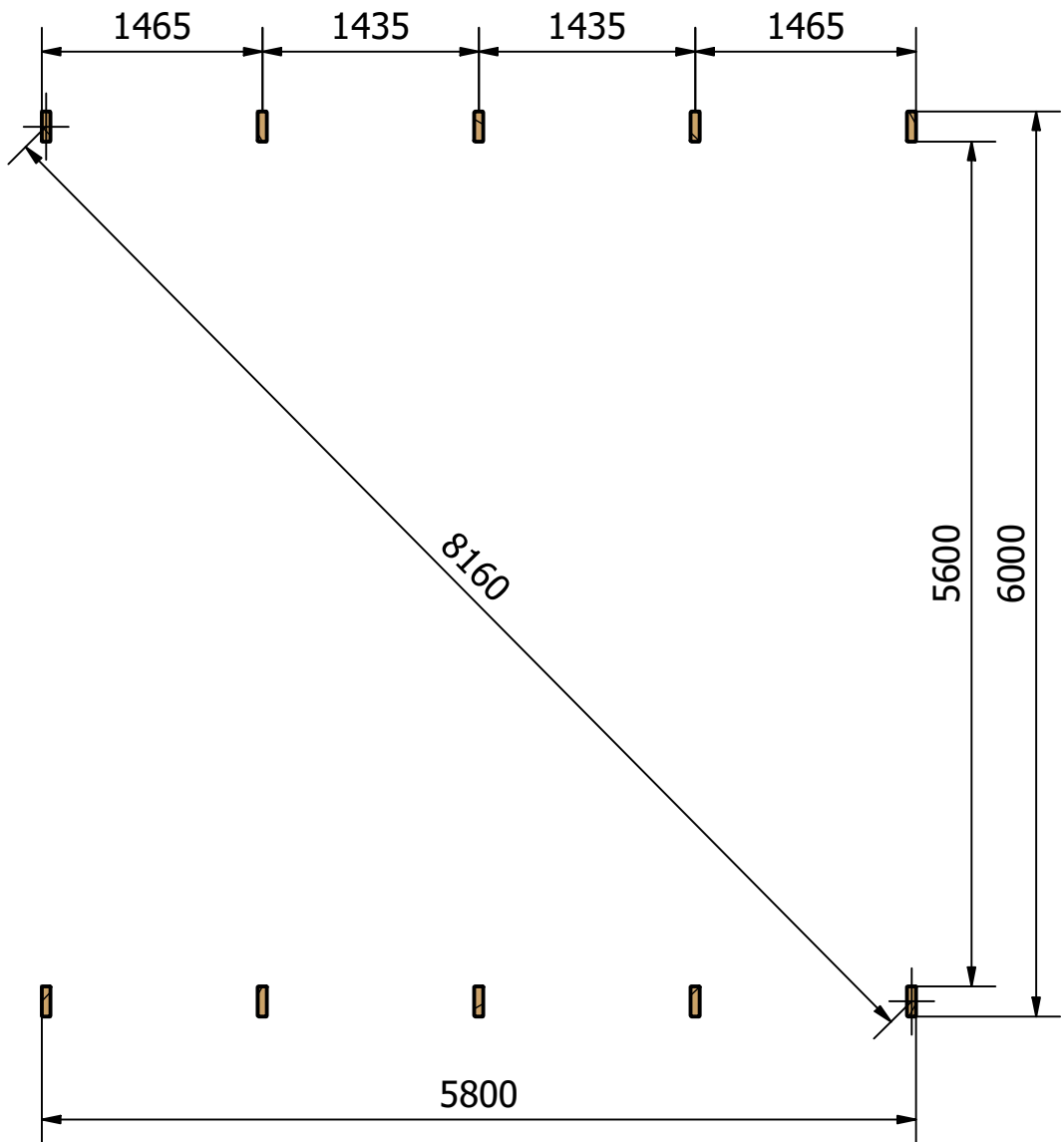
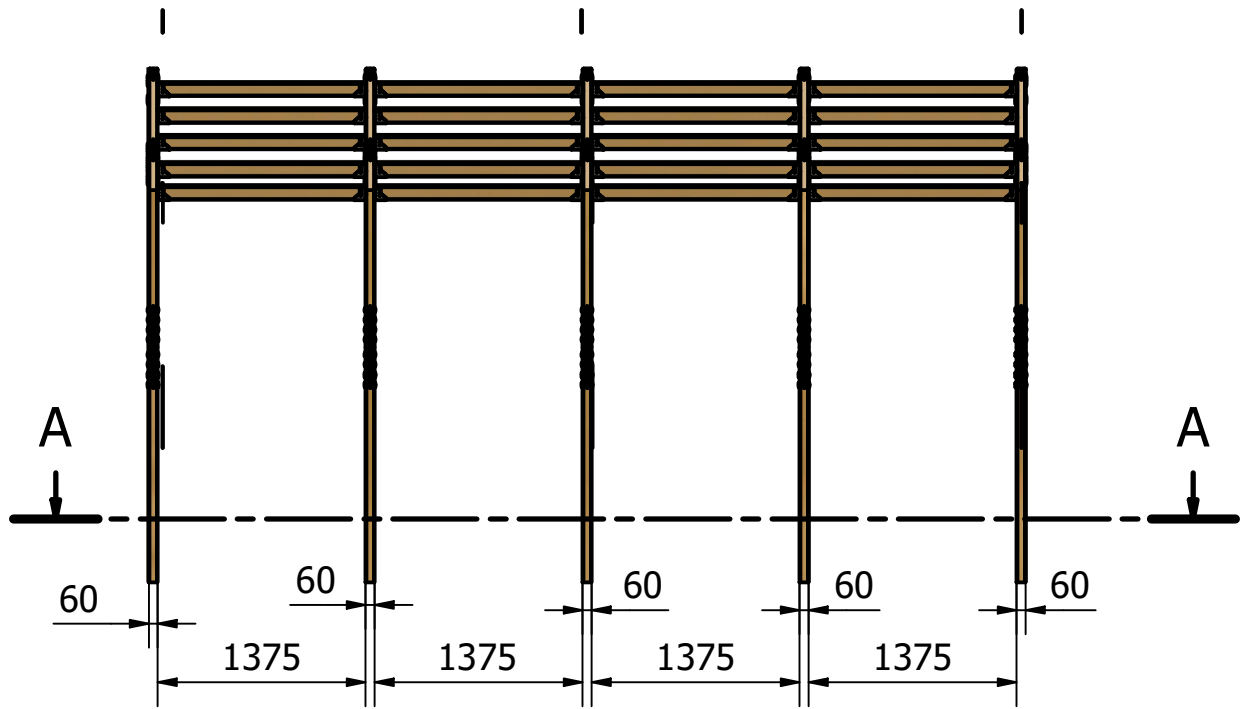

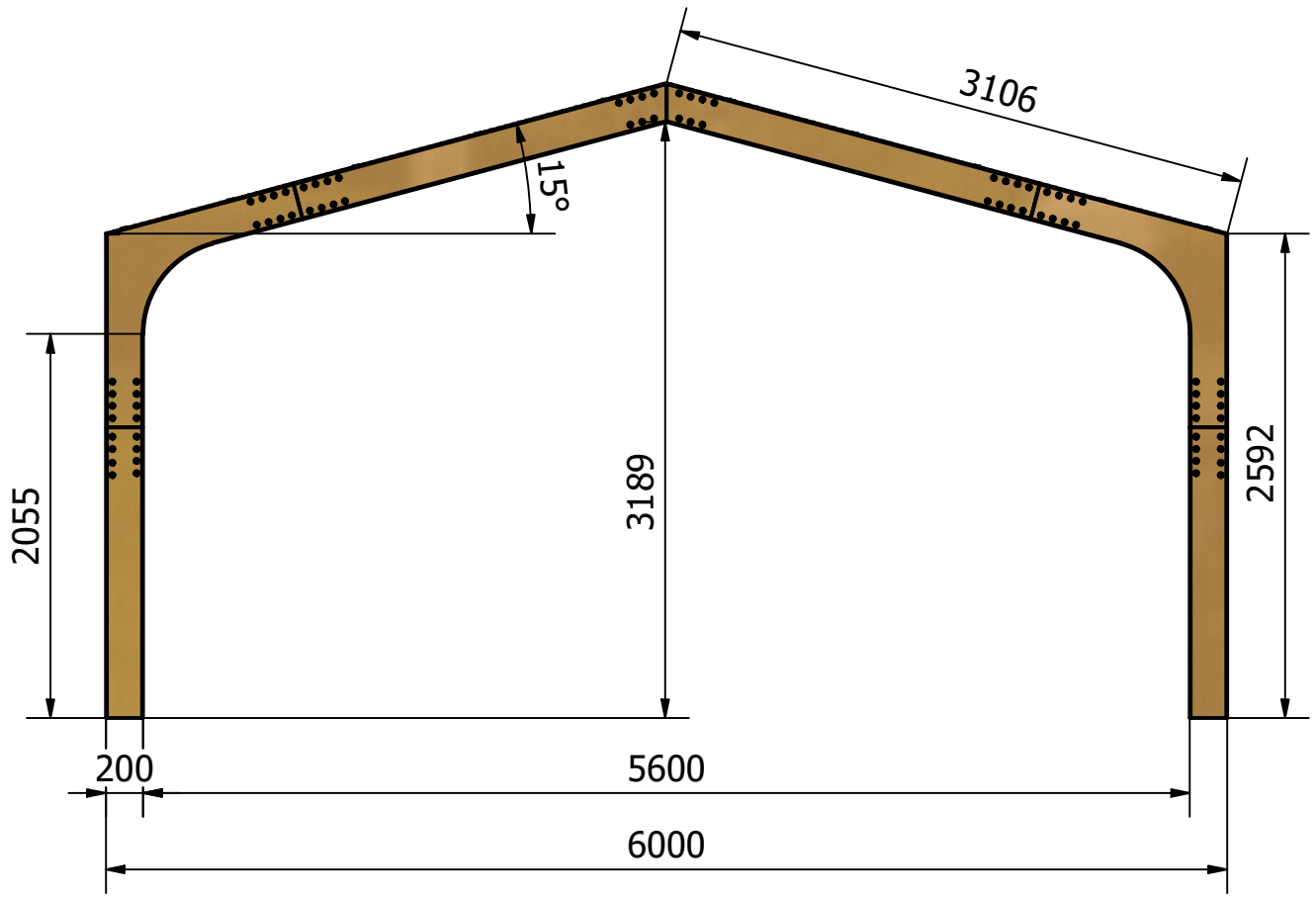

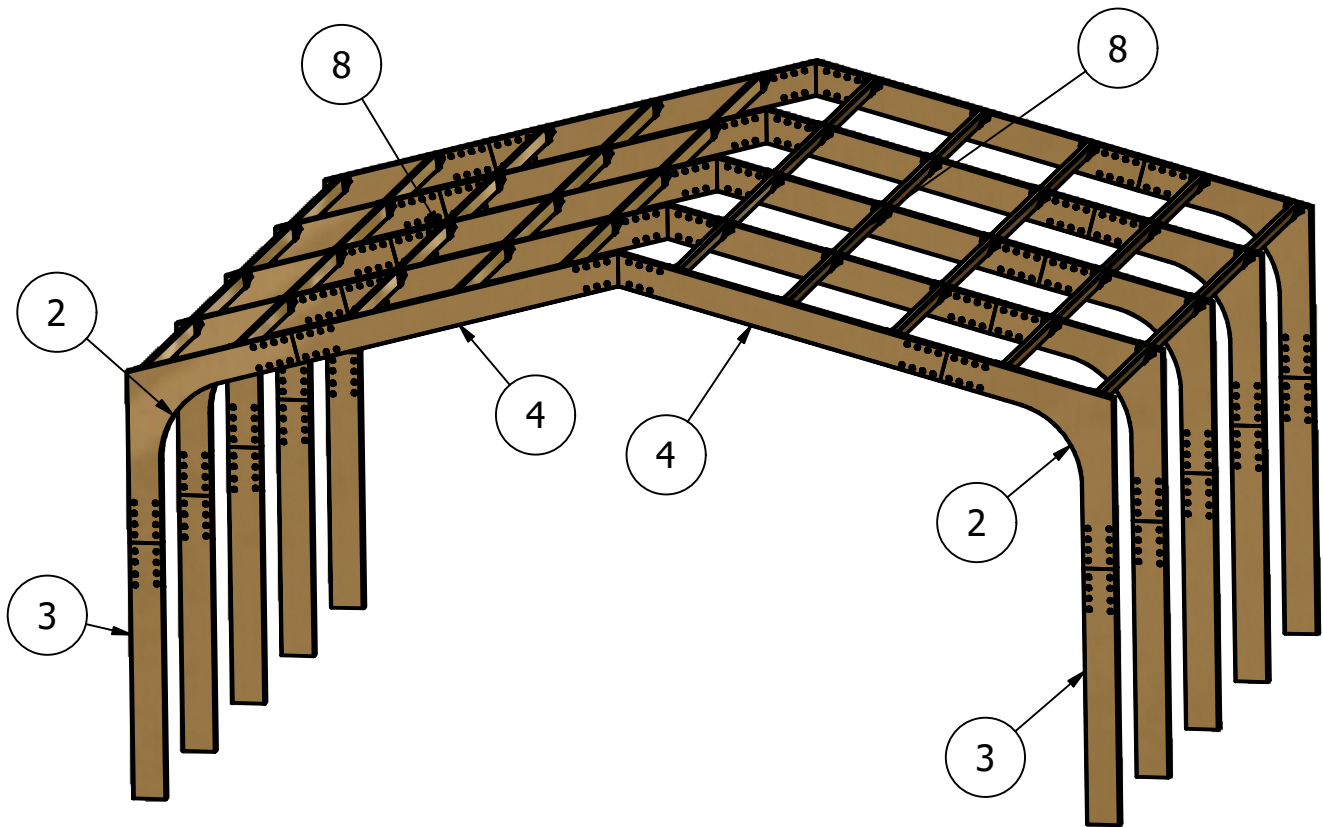

LISTA CZĘŚCI		
POZYCJA	ILOŚĆ	NUMER CZĘŚCI
2	10	R500 60x200x1550 - 15 STOPNI
3	10	slup 60x200x1550
4	10	krokiew 60x200x2070
8	40	KANTÓWKA 40x90x1375

A ( 1 : 15 )

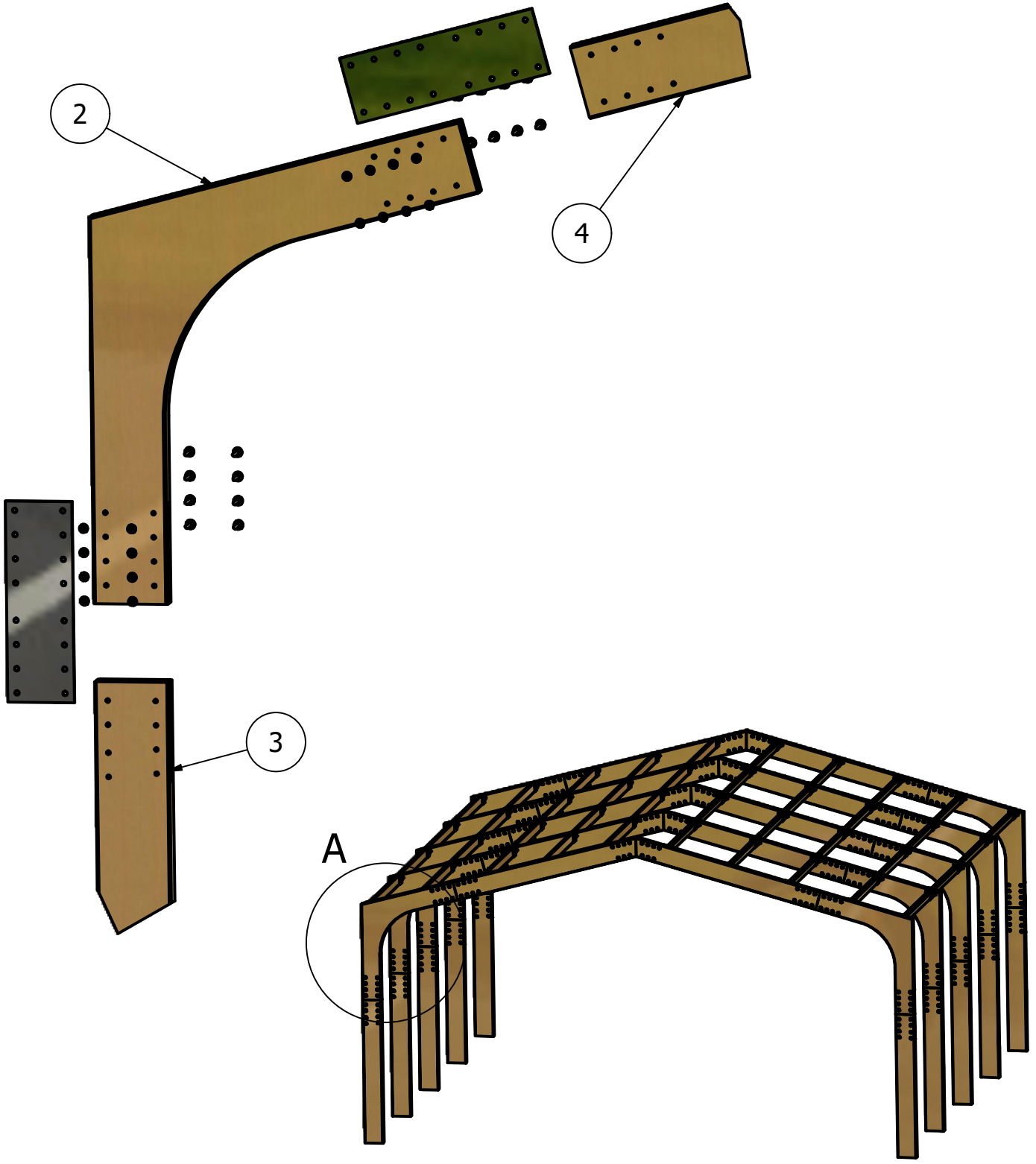

A ( 1 : 10 )

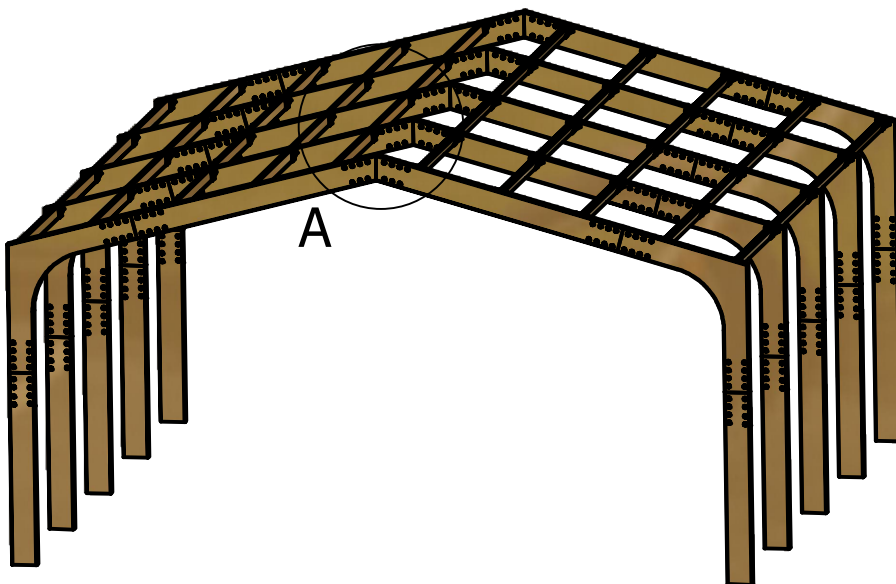
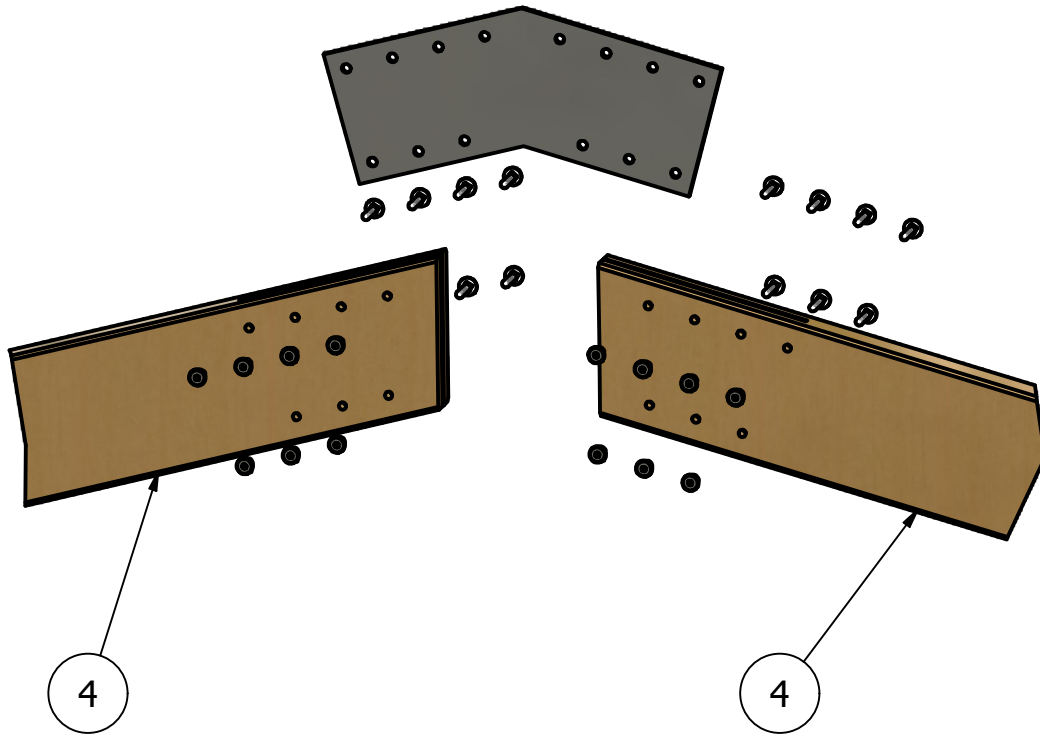

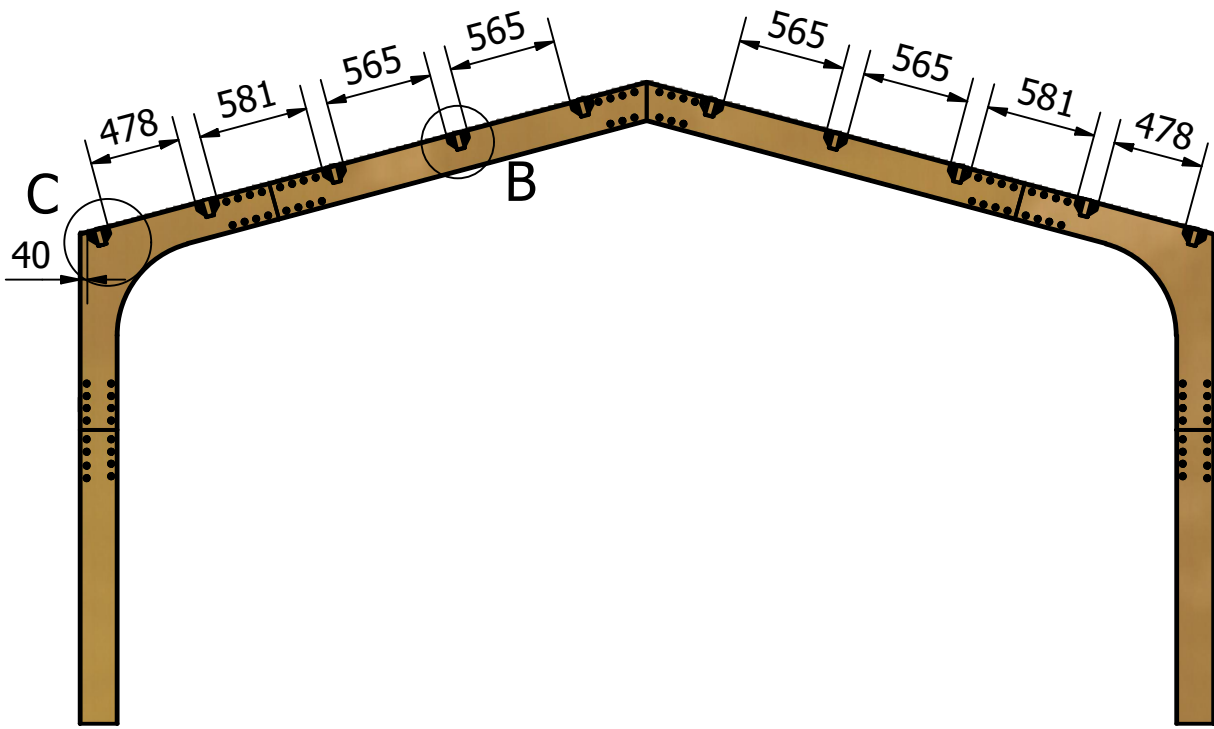

C ( 1 : 10 )

B ( 1 : 10 )

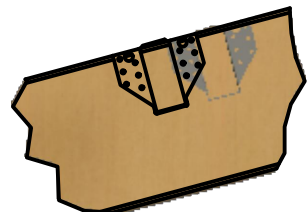
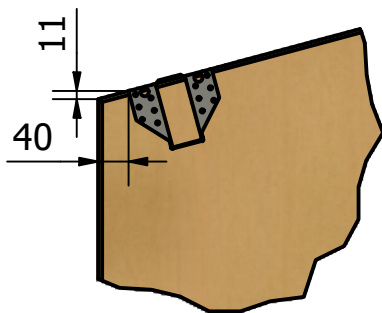

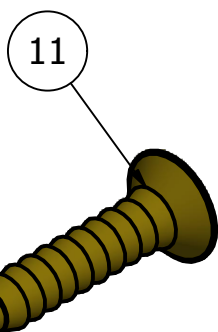
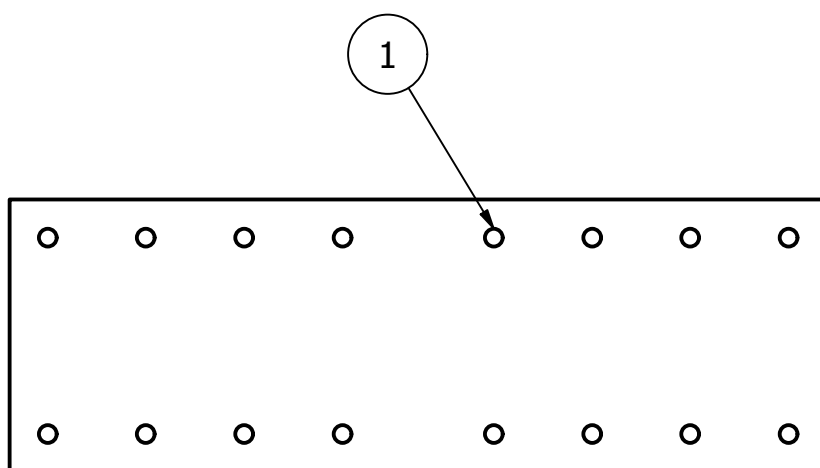
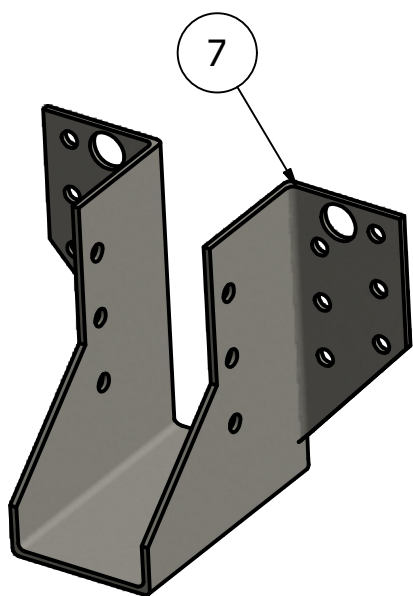
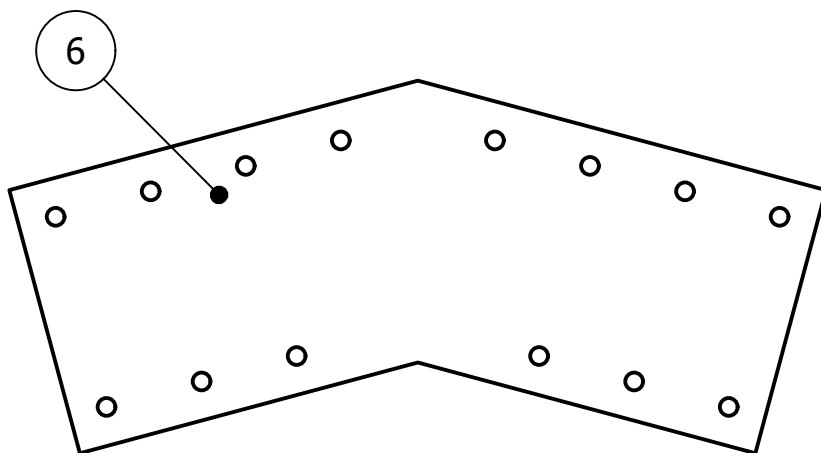
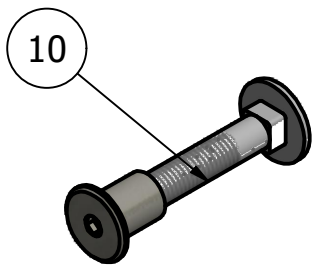

LISTA CZĘŚCI		
POZYCJA	ILOŚĆ	NUMER CZĘŚCI
1	20	blacha 6x180x540
7	80	WIESZAK 40x70x90
8	40	KANTÓWKA 40x90x1375
6	5	BLACHA 6x180x540 WIENIEC
11	1152	WKREŃ 4x20