

Jagram-Pro S.A.



VERONA

L = 525 cm

W = 500 cm

H = 316 cm

Jagram-Pro S.A.

ul. Leśna 16 14-240 Susz

tel. +48 55 2788 497 e-mail: handel@jagram.pl

<https://woodandarch.pl/>

<https://jagram.pl/>

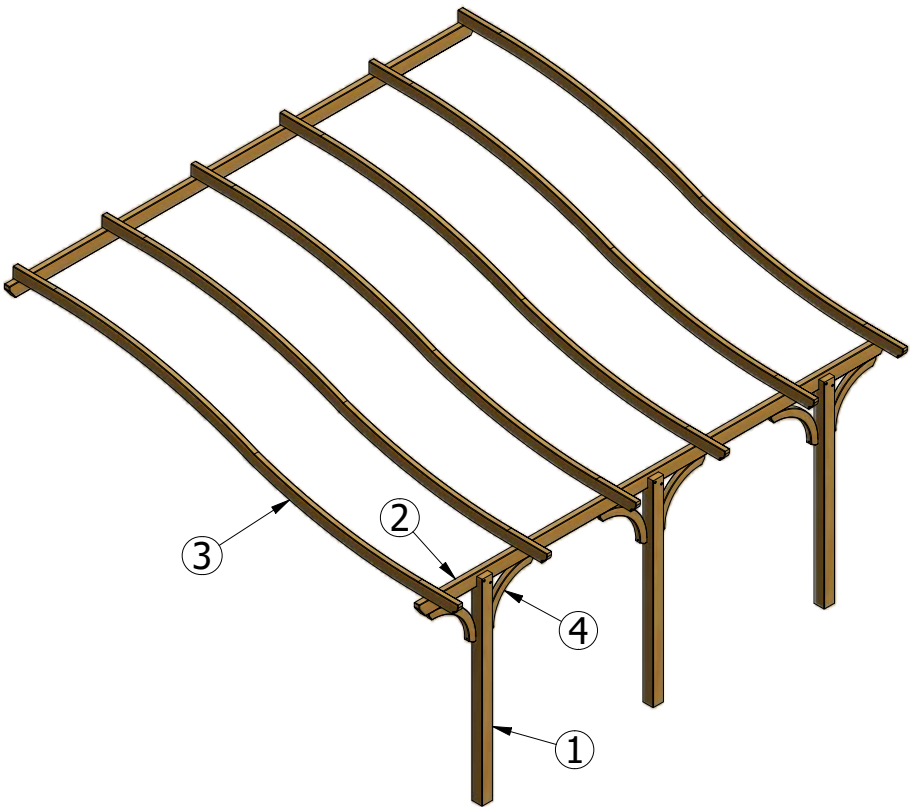
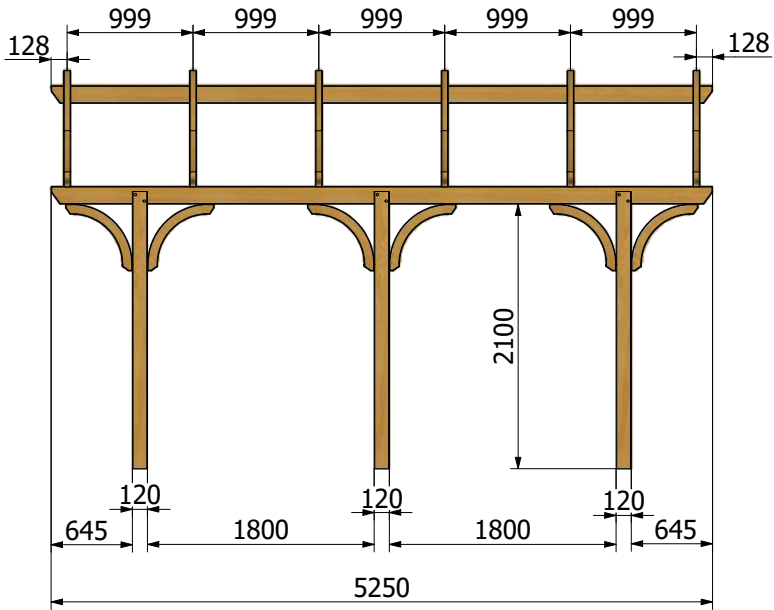

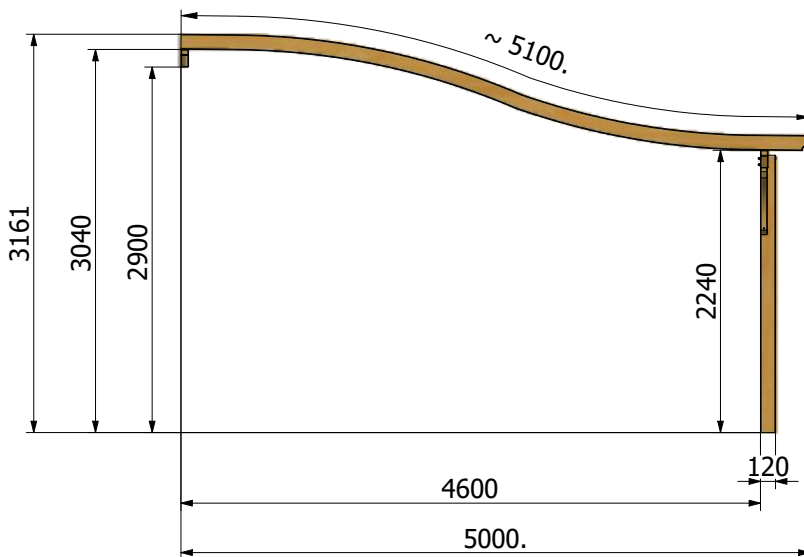

LISTA CZĘŚCI

ELEMENT	ILOŚĆ	NR CZĘŚCI
1	3	kantówka 120x120x2200
2	2	kantówka 60x140x5250
3	6	łuk omega 56x120x5000 R5740 R5740
4	6	łuk 55x80x750Rw400

OKUCIA

ELEMENT	ILOŚĆ	NR CZĘŚCI
A	6	nakrętka kołpakowa M8x15
B	6	podkładka Dw8
C	6	śruba zamkowa 8x130
D	24	wkręt 5x120

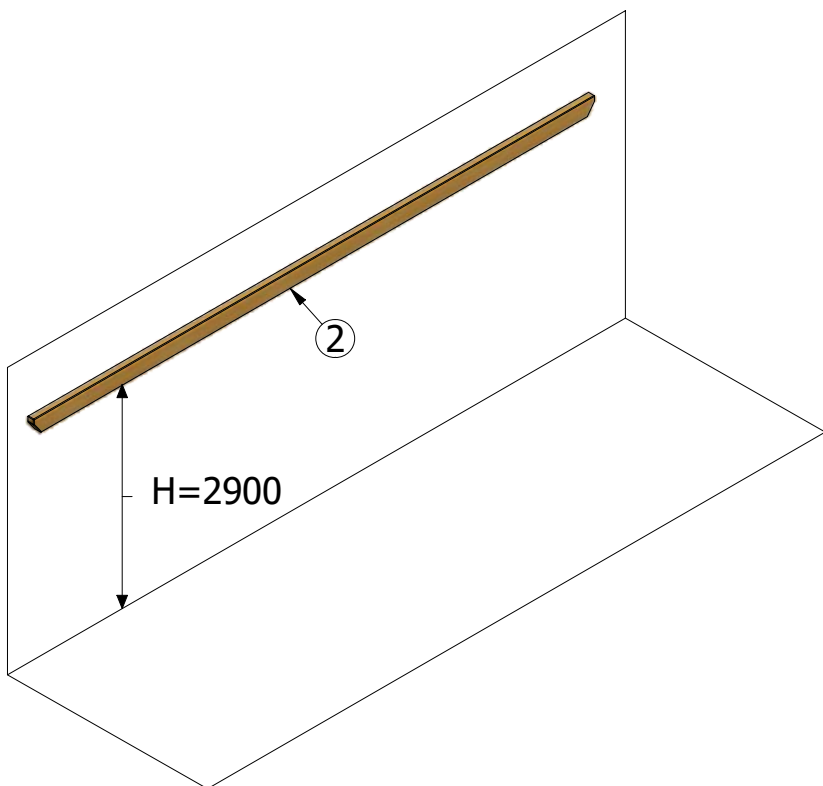

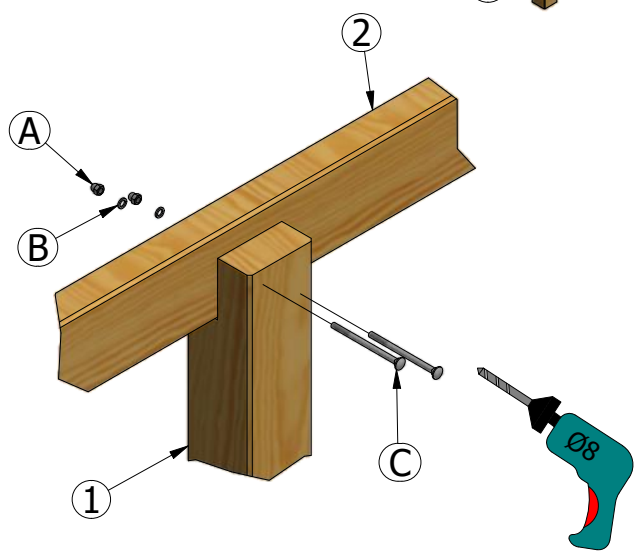
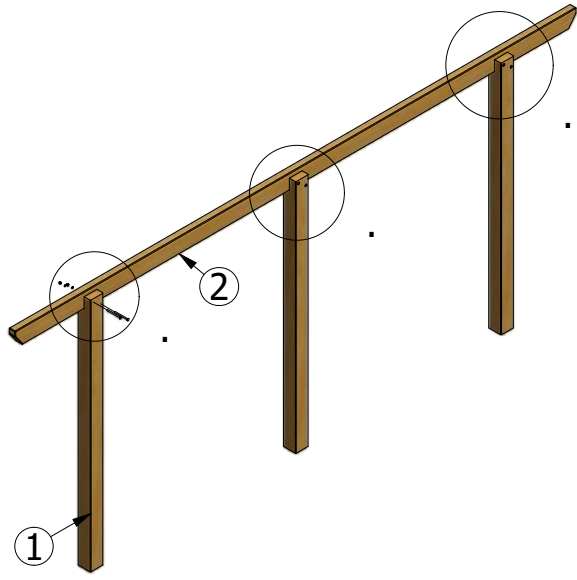
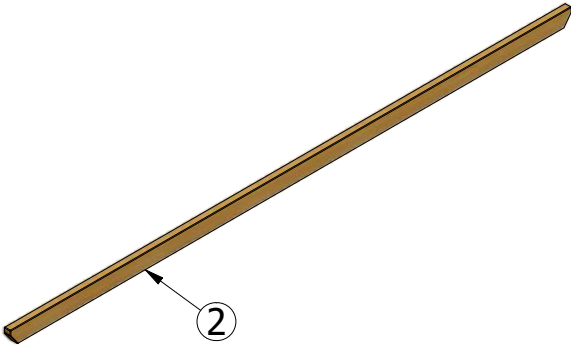

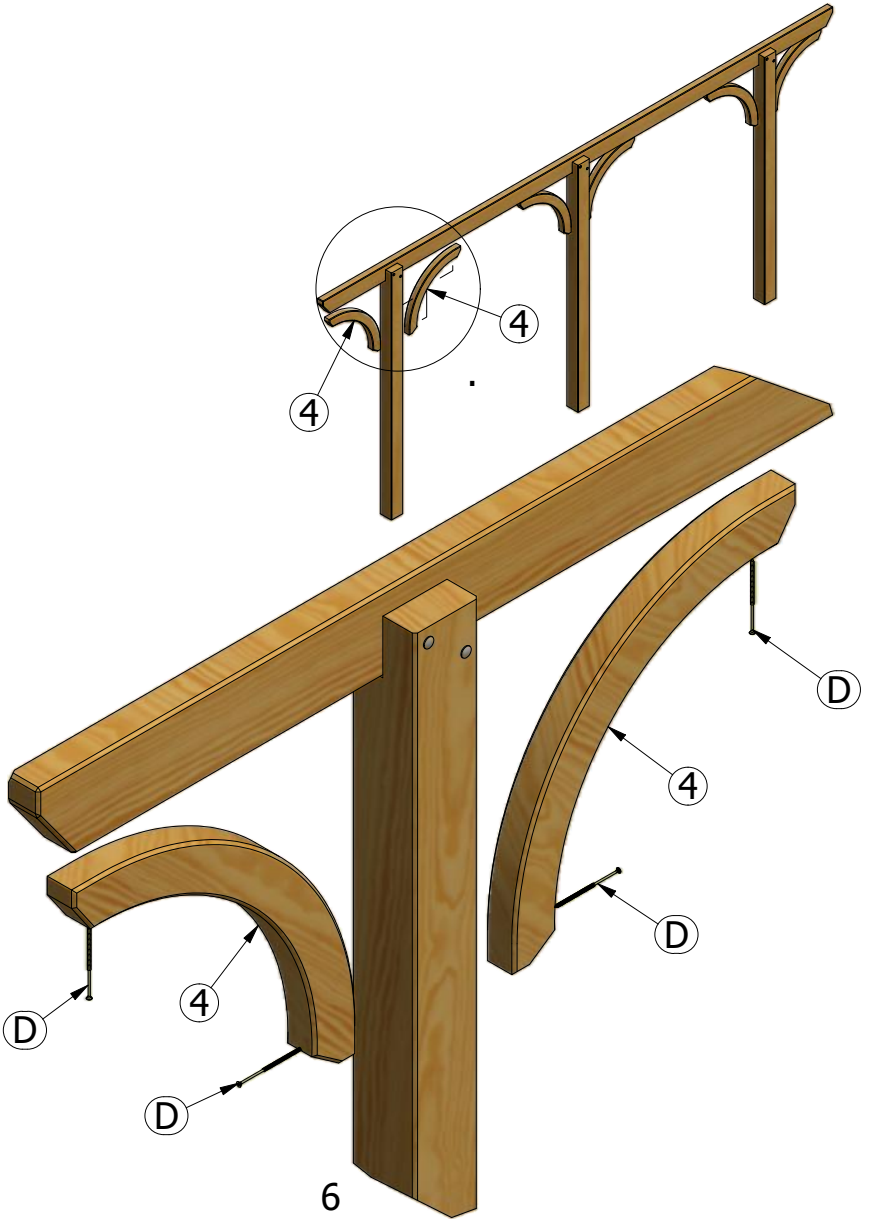
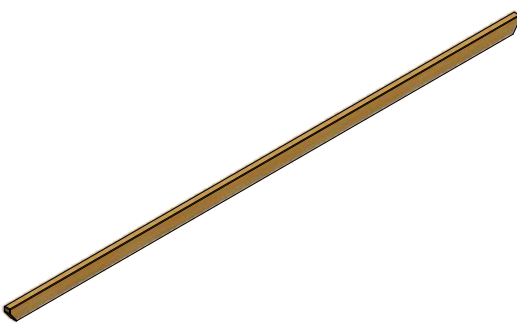

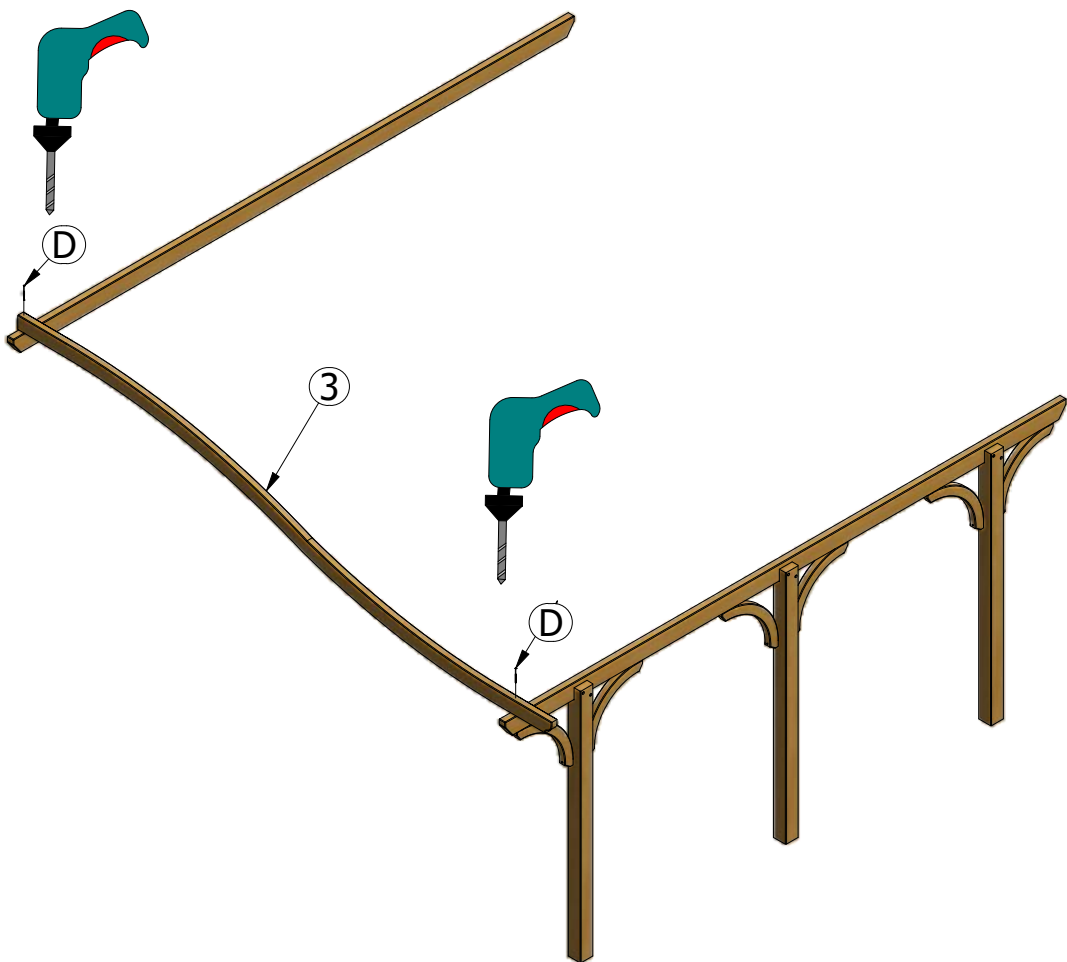

UWAGA: pod wkręty W5x120,
wykonać podwiercenia wiertłem $\text{Ø}12$,
na głębokość 60mm